

E-Series Industrial Grade for Professional Use

For 3/8", 1/2", 3/4" and 1" Hose I.D.

E-Series 12V DC MOTOR DRIVEN HOSE REELS

For applications in the Lawn Care, Pest Control, Agricultural, Service Truck and many Industrial applications.

All reels shipped less hose unless requested on quote basis.

Mounting holes 1/2" dia.

SERIES	DIMENSIONS		
	A	B	C
E15	15	18 1/2	19 1/2
E20	20	23 1/2	24 1/2
E25	25	28 1/2	29 1/2

Product Name:

Hosetract E-Series

Manufacturer:

 Hosetract Industries Inc.
 6433 Discount Drive
 Fort Wayne, IN 46818
 www.hosetract.com

Features:

- Motor sprocket and chain pinch points are safely guarded
- External swivel can be serviced without taking down the reel
- Motor bracket assembly allows ease of chain tightening
- Pre-wire option available
- Mounting base is light and strong
- Heavy duty ABS bearings require no lubrication for years of dependable service.

Notes:

 Reel can be factory pre-wired at additional cost. Prewire Part #9996.
 E-Series Reel must be shipped by truck only.

Standard Accessories:

- Solenoid
- Momentary switch

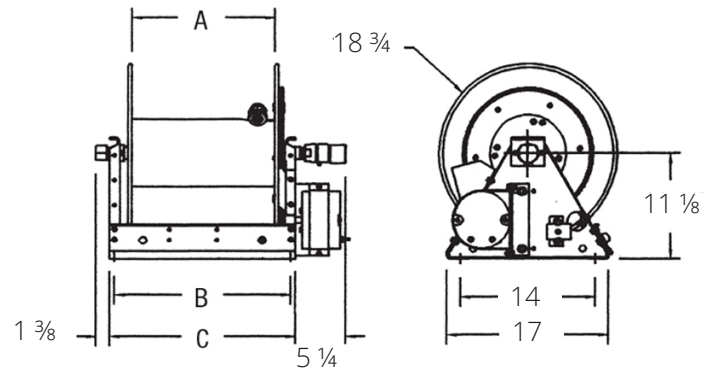
Inlet - (3/8"&1/2") - 1/2" FPT
(3/4"&1") - 1" FPT
Max. Temp. - 200°F

E-Series Industrial Grade for Professional Use

For 3/8", 1/2", 3/4" and 1" Hose I.D.

E-Series - Electric Rewind 12 VDC

Models without hose and hose stop

Model #	Weight	PSI	Hose Capacity 3/8"	Hose Capacity 1/2"	Reel Inlet	Reel Outlet
E 15-5	64	4000	350'	275'	1/2" NPT (F)	1/2" NPT (F)
E 20-5	75	4000	450'	375'	1/2" NPT (F)	1/2" NPT (F)
E 25-5	87	4000	550'	475'	1/2" NPT (F)	1/2" NPT (F)
Model #	Weight	PSI	Hose Capacity 3/4"	Hose Capacity 1"	Reel Inlet	Reel Outlet
E 15-10	66	300	100'	75'	1" NPT (F)	1" NPT (F)
E 20-10	76	300	125'	100'	1" NPT (F)	1" NPT (F)
E 25-10	89	300	150'	125'	1" NPT (F)	1" NPT (F)